

TOSHIBA FIELD EFFECT TRANSISTOR SILICON N CHANNEL MOS TYPE

# 2SK2013

AUDIO FREQUENCY POWER AMPLIFIER APPLICATION

Unit in mm

- High Breakdown Voltage :  $V_{DSS}=180V$
- High Forward Transfer Admittance :  $|Y_{fs}|=0.7S$  (Typ.)
- Complementary to 2SJ313

MAXIMUM RATINGS ( $T_a = 25^\circ C$ )

CHARACTERISTIC	SYMBOL	RATING	UNIT
Drain-Source Voltage	$V_{DSS}$	180	V
Gate-Source Voltage	$V_{GSS}$	$\pm 20$	V
Drain Current	$I_D$	1	A
Power Dissipation ( $T_c = 25^\circ C$ )	$P_D$	25	W
Channel Temperature	$T_{ch}$	150	$^\circ C$
Storage Temperature Range	$T_{stg}$	$-55 \sim 150$	$^\circ C$

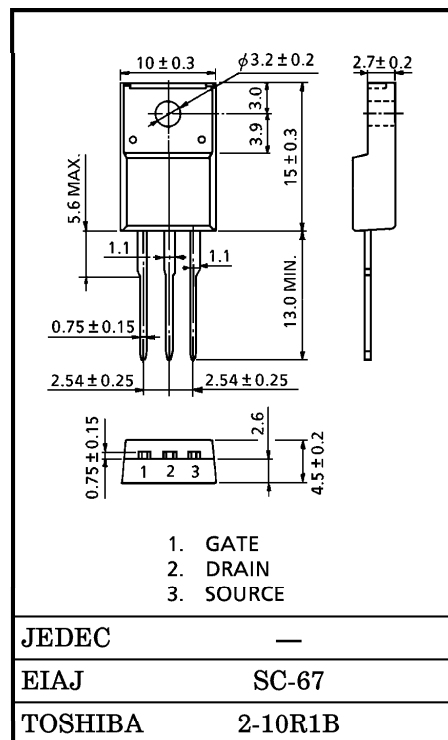

MARKING

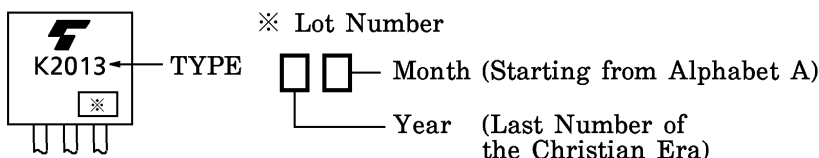

Weight : 1.9g

ELECTRICAL CHARACTERISTICS ( $T_a = 25^\circ C$ )

CHARACTERISTIC	SYMBOL	TEST CONDITION	MIN.	TYP.	MAX.	UNIT
Gate Leakage Current	$I_{GSS}$	$V_{DS}=0, V_{GS}=\pm 20V$	—	—	$\pm 100$	nA
Drain-Source Breakdown Voltage	$V_{(BR) DSS}$	$I_D=10mA, V_{GS}=0$	180	—	—	V
Gate-Source Cut-off Current	$V_{GS(OFF)}$ (Note)	$V_{DS}=10V, I_D=10mA$	0.8	—	2.8	V
Drain-Source Saturation Voltage	$V_{DS(ON)}$	$I_D=0.6A, V_{GS}=10V$	—	1.7	3.0	V
Forward Transfer Admittance	$ Y_{fs} $	$V_{DS}=10V, I_D=0.3A$	—	0.7	—	S
Input Capacitance	$C_{iss}$	$V_{DS}=10V, V_{GS}=0, f=1MHz$	—	170	—	pF
Output Capacitance	$C_{oss}$	$V_{DS}=10V, V_{GS}=0, f=1MHz$	—	45	—	pF
Reverse Transfer Capacitance	$C_{rss}$	$V_{DS}=10V, V_{GS}=0, f=1MHz$	—	17	—	pF

Note :  $V_{GS(OFF)}$  Classification O : 0.8~1.6, Y : 1.4~2.8

**This transistor is the electrostatic sensitive device.  
Please handle with caution.**

961001EAA2

● TOSHIBA is continually working to improve the quality and the reliability of its products. Nevertheless, semiconductor devices in general can malfunction or fail due to their inherent electrical sensitivity and vulnerability to physical stress. It is the responsibility of the buyer, when utilizing TOSHIBA products, to observe standards of safety, and to avoid situations in which a malfunction or failure of a TOSHIBA product could cause loss of human life, bodily injury or damage to property. In developing your designs, please ensure that TOSHIBA products are used within specified operating ranges as set forth in the most recent products specifications. Also, please keep in mind the precautions and conditions set forth in the TOSHIBA Semiconductor Reliability Handbook.

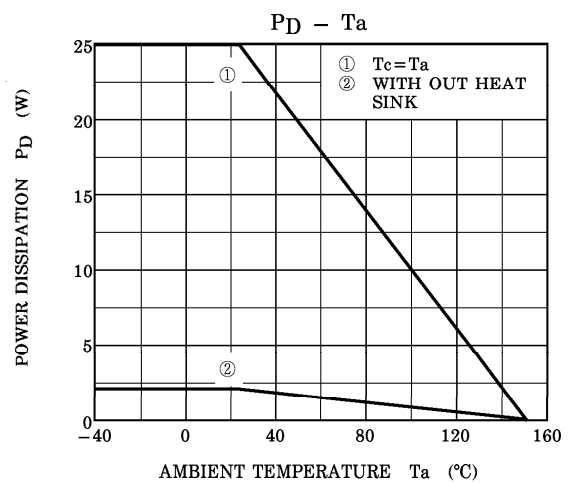
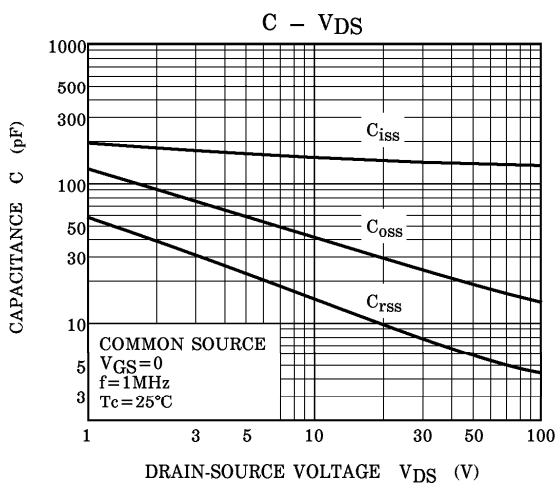
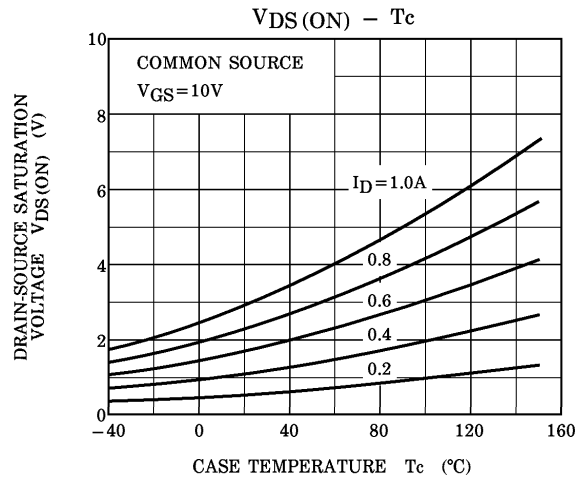
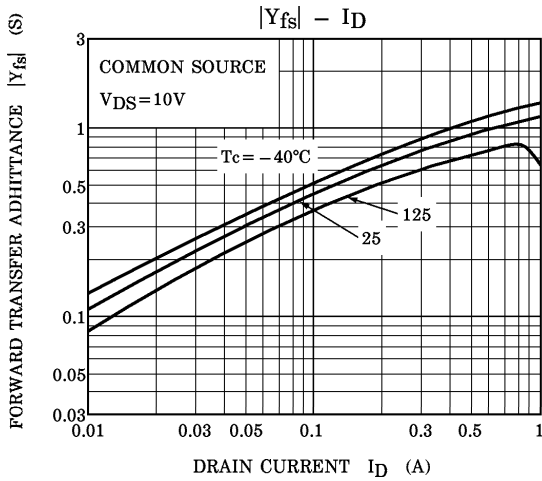
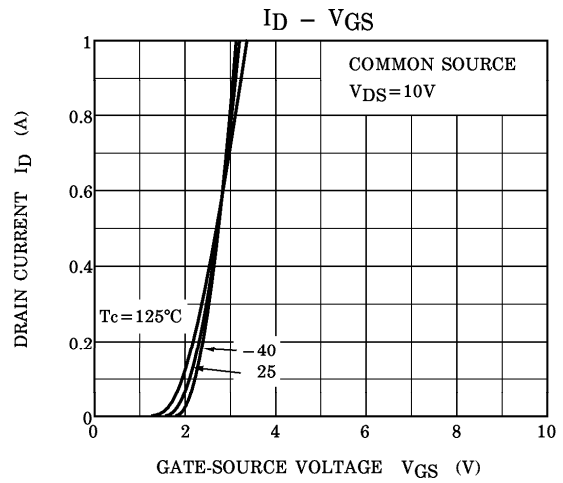
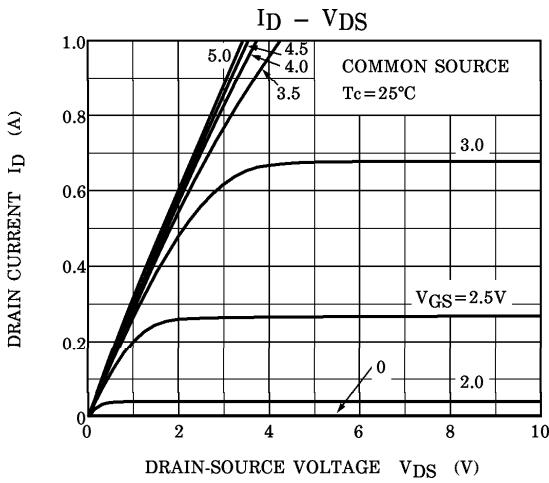

961001EAA2'

● The information contained herein is presented only as a guide for the applications of our products. No responsibility is assumed by TOSHIBA CORPORATION for any infringements of intellectual property or other rights of the third parties which may result from its use. No license is granted by implication or otherwise under any intellectual property or other rights of TOSHIBA CORPORATION or others.  
 ● The information contained herein is subject to change without notice.

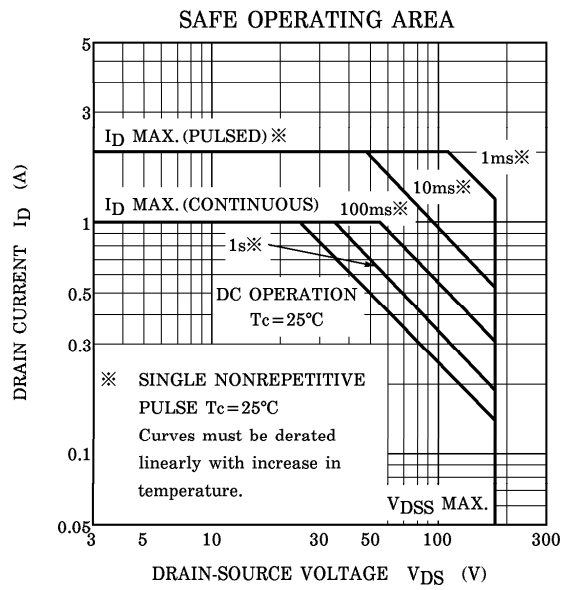
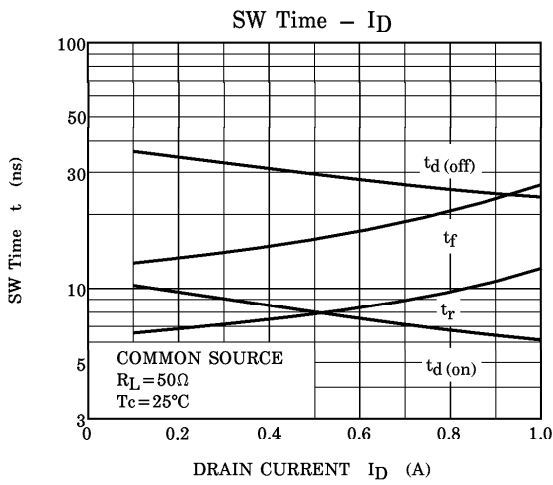

TEST CIRCUIT

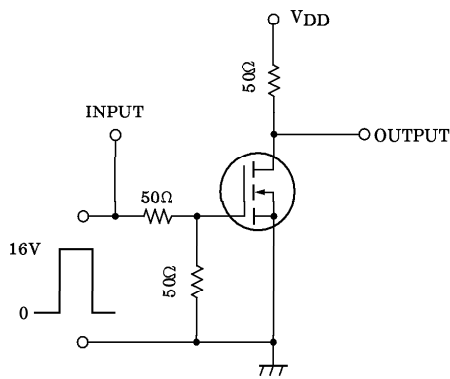

WAVEFORMS

